

IT 1902

2D-code hand-held scanner with Bluetooth data transmission

en 02-2014/07 50115721-01



Dimensioned drawing

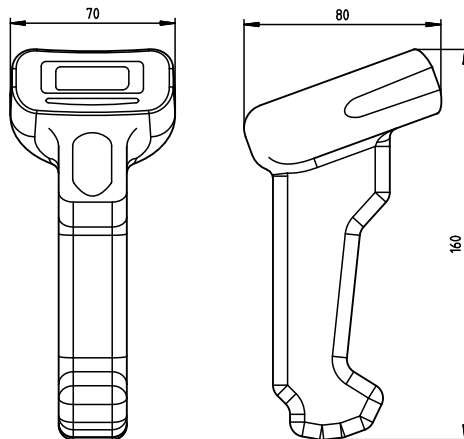

Hand-held scanner
IT 1902g XX-2
with Bluetooth

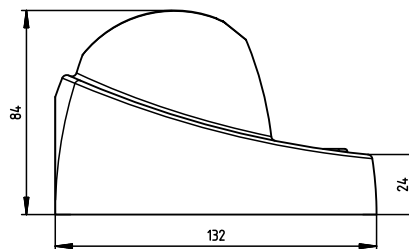

Bluetooth base station
Base f. IT 1902

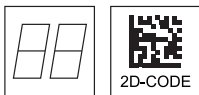
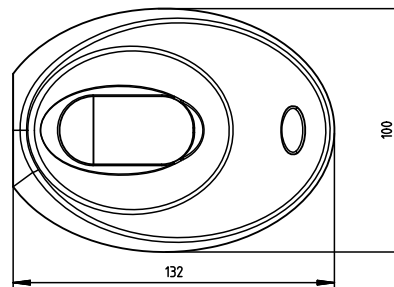

- Hand-held scanner for 2D codes and bar codes
- Transmission to base station via Bluetooth standard V2.1
- Large reading field for the detection of high-contrast codes
- Robust trigger button
- Built-in decoder
- Read-display
- RS 232, USB and PS/2 interface
- Operating temperature from 0°C through 50°C

Electrical connection

for RS 232 cable

9-pin Sub-D	Signal	Base f. IT 1902 RJ41
2	TXD	4
3	RXD	5
5	GND	3
7	CTS	6
8	RTS	8
9	5VDC	7

for USB cable

USB type A	Signal	Base f. IT 1902 RJ41
1	5VDC	7
2	Data -	10
3	Data +	9
4	GND	3

for PS/2 cable

Mini DIN connector	Mini DIN socket	Signal	Base f. IT 1902 RJ41
1	-	PC Data	4
2	2	NC	
3	3	GND	3
4	4	5VDC	7
5	-	PC Clock	5
6	6	NC	
-	1	KB Data	8
-	5	KB Clock	6



Accessories

- **TTL-RS 232 cable**
part no. 50114517
- **PS/2 cable**
part no. 50114519
- **USB cable, 3m**
part no. 50114521
- **USB helix cable, 5m**
part no. 50114523
- **Power supply unit**
part no. 50114525

We reserve the right to make changes * DS_IT1902_en_50115721_01.fm

Specifications

Electrical data

Operating voltage U_B
Power consumption

IT 1902g XX-2
3.7VDC internal battery

Base f. IT 1902
4.5 ... 5.5VDC
max. 5W @ 5VDC

Li-ion battery

Capacity 2.000mAh
Max. number of scans 50.000
Max. operating time 14h at 1 scan/s
Charging time at 9VDC 4,5h for complete charge following complete discharge

RF data transmission

Frequency 2.4 ... 2.4835GHz (ISM band)
Frequency hopping, Bluetooth® V2.1, Class 2
Typ. Range 10m
Transmission speed up to 1 MBit/s

Interfaces

Interface type RS 232, PS/2 and USB
Trigger via button or serial command

Code types

2D codes Data Matrix ECC 200, MaxiCode, PDF417, MicroPDF, QR Code, Aztec, Aztec Mesas, Code 49, EAN/UCC Composite
Bar codes 2/5 Interleaved, Code 39, Code 128, Code 93, Codabar, UPC/EAN, Codablock, GS1 Databar

Optical data

Optical system high-resolution pixel array 838x640
Symbol contrast PCS 20% minimum
Light source integrated diffuse LED, wavelength 617nm ± 18nm
Read direction omnidirectional, various tilt and rotational angles up to 45°

Mechanical data

Weight	213g	Base f. IT 1902	179g (without cable)
Dimensions	104x71x160mm		101x131x81mm
Shock resistance	50 falls from a height of 1.8m		50 falls from a height of 1m

Environmental data

Ambient temp. (operation)	0°C ... +50°C	0°C ... +50°C
Ambient temp. (storage)	-40°C ... +70°C	-40°C ... +60°C
Relative air humidity	0 ... 95% (non-condensing)	0 ... 95% (non-condensing)
Light source	exempt group (in acc. with EN 62471)	
Protection class	IP 41	IP 41
Certifications	IEC 60950-1 (US-19749-A1-UL)	

Tables

Remarks

Operate in accordance with intended use!

- ☞ The product may only be put into operation by competent persons.
- ☞ Only use the product in accordance with the intended use.

Ergonomically shaped hand-held scanner with integrated decoder for high-contrast codes.

Data transmission via configurable RS 232 interface.

Or keyboard-wedge operation via PS/2 or USB interface.

For a functional unit, an IT 1902 hand-held scanner and a Base f. IT 1902 base station as well as a power supply unit and corresponding cable must be ordered.



Bluetooth is a trademark owned by Bluetooth SIG, Inc., U.S.A. and licensed to Honeywell.

Reading field

IT 1902g HD-2

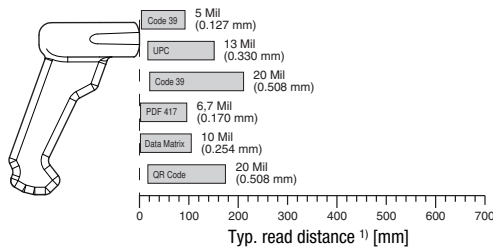

IT 1902g SR-2

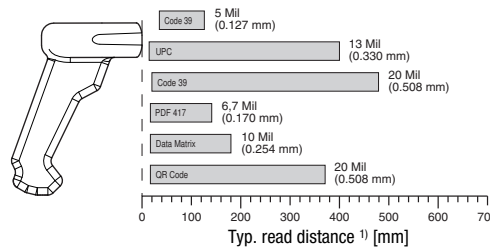

IT 1902g ER-2

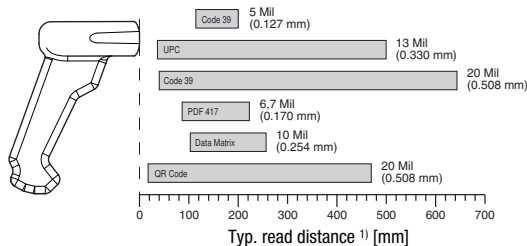

1) Dependent on code module

Order guide

2D code hand-held scanner (special optics for very small codes)

IT 1902g HD-2 with Bluetooth transmission

Part No.
50114513

2D-code hand-held scanner (standard range)

IT 1902g SR-2 with Bluetooth transmission

Part No.
50114515

2D code hand-held scanner (special optics with large range)

IT 1902g ER-2 with Bluetooth transmission

Part No.
50114511

Base station for 2D-code hand-held scanner with Bluetooth data transmission

Base f. IT 1902 with RS 232, PS/2 and USB interface

Part No.
50114492

Switching off the computer

Information on switching off and shutting down the connected computer - which must always be performed before connecting peripheral devices, such as a scanner - can be found in the appropriate operating instructions for your computer.

Connecting the base station

Shown in the figure to the right are the locations for installing the cable on the base station. The individual installation steps are described in the following.

1. To secure the interface cable to the base station, proceed as follows: plug the RJ 41 connector into the socket on the bottom of the base station until the cable clicks into place.
2. Connect the interface cable to the appropriate connection socket on the computer.
3. You may need a power supply unit for voltage supply if you would like to charge the hand-held scanner at the base station or if you use an RS 232 interface. Use the pin assignments (see "Electrical connection" on page 1) to select the appropriate cable for your application.
4. Connect the power supply unit to the power socket.
5. Use the code for the respective application to configure the hand-held scanner, see chapter "Configuration".
6. Check the operational readiness of the scanner by pointing the scanning surface towards a flat surface and pulling the trigger. A green target line as well as the red illumination should now be visible. Now scan a sample label. The scanner emits an audible signal to confirm that the label has been read; if necessary, the data are now passed on to the computer.

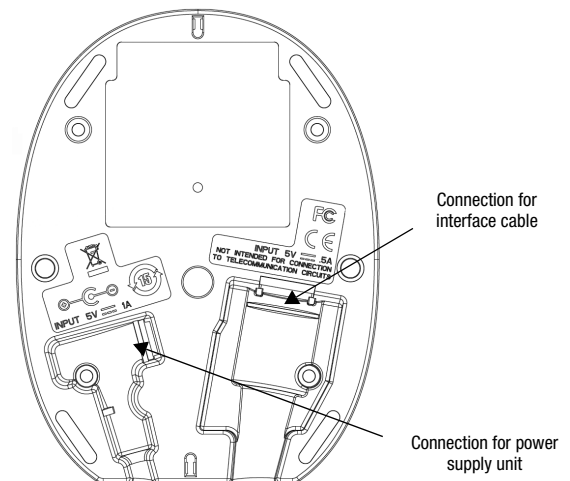

Configuration

The hand-held scanner can always be configured using bar codes. To do this, the bar code must first be selected on the package insert and then the trigger actuated in order to read the code. The configuration is then immediately accepted and executed.

Several of the most important configurations are listed in the following.

A second option is to configure the hand-held scanner with the USB and RS 232 interfaces with the aid of the **EZ Config** PC program. You can download and install this program from our homepage at www.leuze.de.

The program can be used to make settings and transfer them to the hand-held scanner. The configuration can also be stored so that it can be reused at a later time.

Further information on this can be found in the User's Guide for the IT 1900/IT 1902.

The standard applications are described and summarised below.

Notice!

Additional information on the device and short instructions can be found on the Internet at www.leuze.de.

Resetting the IT 1902 to factory settings

To reset all parameters to factory settings, scan the adjacent bar code.



Attention!

All settings are lost!!!

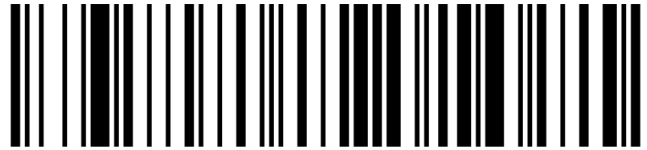

Return the IT 1902 to the base station to apply the settings. This procedure is concluded with audible confirmation signals. You may then continue making settings or operation of the device.

Trigger

To activate the read process, a trigger signal is to be sent via the serial RS 232 interface or USB interface (COM port emulation only). The command is to be sent at the set baud rate, parity, and data and stop bits.

The command for activation is: **SYN T CR** ASCII decimal values: 022; 084; 013

To cancel read readiness, send a deactivation.

The command for deactivation is: **SYN U CR** ASCII decimal values: 022; 085; 013

Following a successful read operation, the IT 1902 deactivates itself.

The second option is activation via the built-in trigger button.

Configuration for the Leuze standard protocol

Scan the adjacent 2D code.

The IT 1902 is set to the following transmission parameters:

RS 232 transmission with 9,600 baud, 8 data bits, 1 stop bit, no parity, prefix <STX>, terminators <CR><LF>.

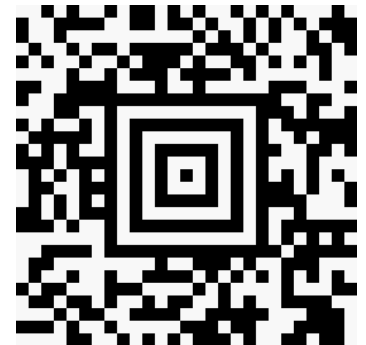

Connecting the IT 1902 to the serial PC interface

With TTL-RS232 cable (part no. 50114517)

required parts:

- 1x IT 1902g XX-2
- 1x 50114492 Base f. IT 1902 base station
- 1x 50114517 KB 232-1 IT 190x
- 1x 50114525 Power supply unit

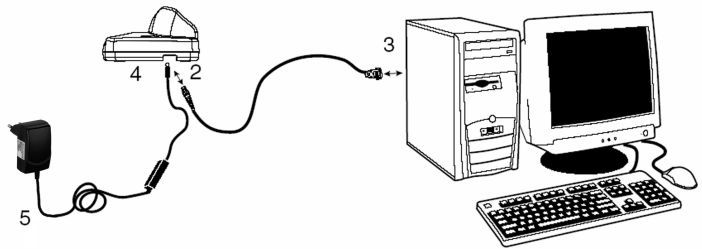

Notice!

The **KB 232-1 IT190x** cable (part. no. 50114517) uses TTL level (0V...5V) for data transmission. Alternatively, the **KB 232-2 IT190x** cable (part. no. 50115105) can be used which works with the regular RS232 level (-12V...+12V) and therefore features a higher interference rejection. Both cables are connection compatible.

Procedure:

1. Switch off the PC.
2. Connect the interface cable to a free COM port (RS 232) on the computer (3) and to the base station (2).
3. Plug one end of the power supply unit cable into the base station (4) and the other end into a free power socket (5).
4. Switch the PC back on.
5. Scan the adjacent bar code.



The IT 1902 is set to the following transmission parameters:

RS 232 transmission with 115,200 baud, 8 data bits, 1 stop bit, no parity, terminators <CR><LF>.

6. Return the IT 1902 to the base station to apply the settings. This procedure is concluded with optical confirmation signals (green LED on the base station).
7. If necessary, adjust the transmission parameters of the used COM port to those of the IT 1902.



Attention!

We recommend connecting the base station directly to a PC or to the MA 21 or MA 41... connector units. If connecting to other components, please note that a voltage level range of 0 ... +5V (TTL level) is maintained on the data lines!

Connecting the IT 1902 to the MA 41 DP-K or MA 41 IS

required parts:

1x	IT 1902g XX-2	
1x	50114492	Base f. IT 1902 base station
1x	50114517	KB 232-1 IT 190x
1x	50114525	Power supply unit
1x	50035421	KB 021 Z
1x	50033638	MA 41 DP-K for Profibus (for Interbus: 50028994 MA 41 IS or 50030085 MA 41 IS PDP)

Pin assignments KB 021 Z:

Core colour:	signal	terminal in the MA 41:
brown	(RXD)	2
white	(TXD)	1
blue	(GND)	4
red	(VCC)	⊗
black	(GND)	⊗
bare (shield)	(PE)	21

Procedure:

1. Connect cable KB 021 Z to the MA 41... acc. to the above pin assignments.
2. Connect the interface cable to cable KB 021 Z. Connect the interface cable and the power supply unit to the base station (see "Connecting the IT 1902 to the serial PC interface").
3. Scan the adjacent 2D code.

The IT 1902 is set to the following transmission parameters:

RS 232 transmission with 9,600 baud, 8 data bits, 1 stop bit, no parity, terminators
<CR><LF>.

4. Return the IT 1902 to the base station to apply the settings. This procedure is concluded with audible confirmation signals.

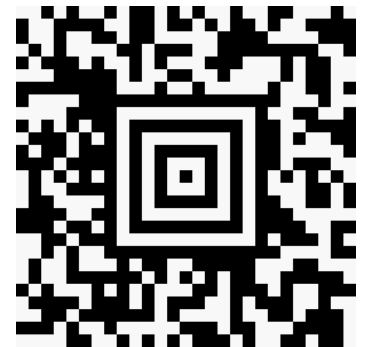

Connecting the IT 1902 to the MA 21

required parts:

1x	IT 1902g XX-2
1x 50114492	Base f. IT 1902 base station
1x 50114517	KB 232-1 IT 190x
1x 50114525	Power supply unit
1x 50035421	KB 021 Z
1x 50030481	MA 21 100

Pin assignments KB021 Z:

Core colour:	signal	terminal in the MA 21:
brown	(RXD)	26
white	(TXD)	27
blue	(GND)	28
red	(VCC)	⊗
black	(GND)	⊗
bare (shield)	(PE)	21

Procedure:

1. Connect cable KB 021 Z to the MA 21... acc. to the above pin assignments.
2. Connect the interface cable to cable KB 021 Z. Connect the interface cable and the power supply unit to the base station (see "Connecting the IT 1902 to the serial PC interface").
3. Scan the adjacent 2D code.

The IT 1902 is set to the following transmission parameters:

RS 232 transmission with 9,600 baud, 7 data bits, 1 stop bit, even parity, terminators <CR><LF>.

4. Return the IT 1902 to the base station to apply the settings. This procedure is concluded with audible confirmation signals.

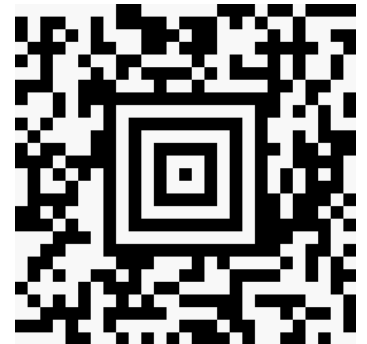

Connecting the IT 1902 to the PS/2 interface

The operation of the IT 1902 in keyboard emulation mode is described in this section. A PC keyboard is emulated in this operating mode. The data which are read in are written directly to the currently activated program. Thus, the data can be processed further in all standard programs.

required parts:

- 1x IT 1902g XX-2
- 1x 50114492 Base f. IT 1902 base station
- 1x 50114525 Power supply unit
- 1x 50114519 KB PS2-1 IT 1902

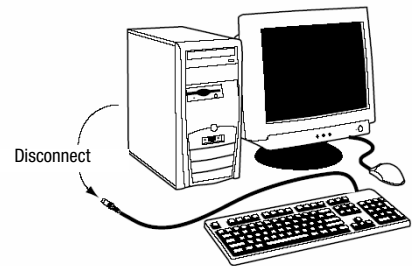

Procedure:

1. Switch off the PC.
2. Disconnect the keyboard.
3. Connect the cable for the base station between the keyboard and the PC.
4. Switch the PC back on.
5. Scan the 2D code shown below.
6. Return the IT 1902 to the base station to apply the settings. This procedure is concluded with audible confirmation signals.

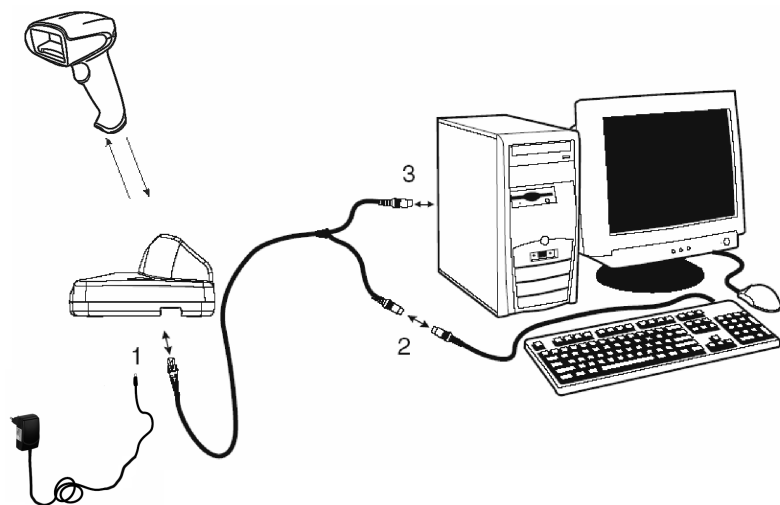

Notice!

To charge the IT 1902, the power supply unit must be plugged in and the hand-held scanner placed in the base station.



IT 1902

2D-code hand-held scanner with Bluetooth data transmission

Connecting the IT 1902 to the USB interface (keyboard emulation)

The operation of the IT 1902 in keyboard-emulation mode on a USB port is described in this section. A PC keyboard is emulated in this operating mode. The data which are read in are written directly to the currently activated program. Thus, the data can be processed further in all standard programs.

required parts:

- 1x IT 1902g XX-2
- 1x 50114492 Base f. IT 1902 base station
- 1x 50114525 Power supply unit
- 1x 50114521 KB USB-1 IT190x (3m, straight)
- or
- 1x 50114523 KB USB-2 IT190x (5m, spiral)

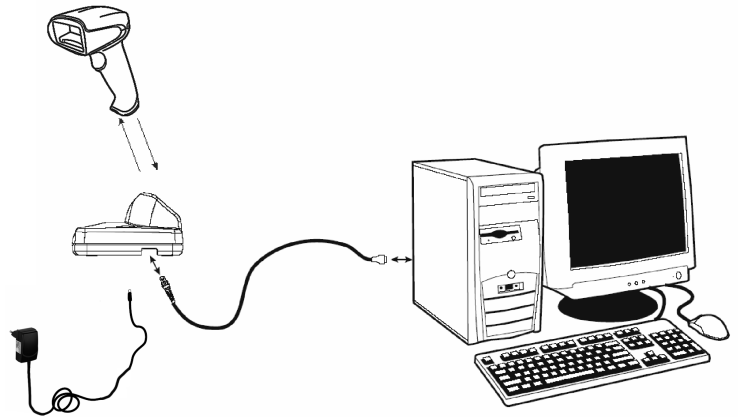

Procedure:

1. Connect the cable for the base station to a free USB port.
2. The scanner acknowledges this connection with a beep.
3. Scan the adjacent 2D code.



Notice!

To charge the IT 1902, the power supply unit must be plugged in and the hand-held scanner placed in the base station.



Connecting the IT 1902 to the USB interface (COM-port emulation)

The operation of the IT 1902 as a serial interface on a USB port is described in this chapter. A COM interface is emulated in this operating mode. The data which are read in are sent to a new COM interface. The driver with which you emulate this COM interface can be downloaded from our homepage at www.leuze.de. Thus, the data can be processed further in programs which expect data via COM interfaces.

required parts:

- 1x IT 1902g XX-2
- 1x 50114492 Base f. IT 1902 base station
- 1x 50114525 Power supply unit
- 1x 50114521 KB USB-1 IT190x (3m, straight)
- or
- 1x 50114523 KB USB-2 IT190x (5m, spiral)

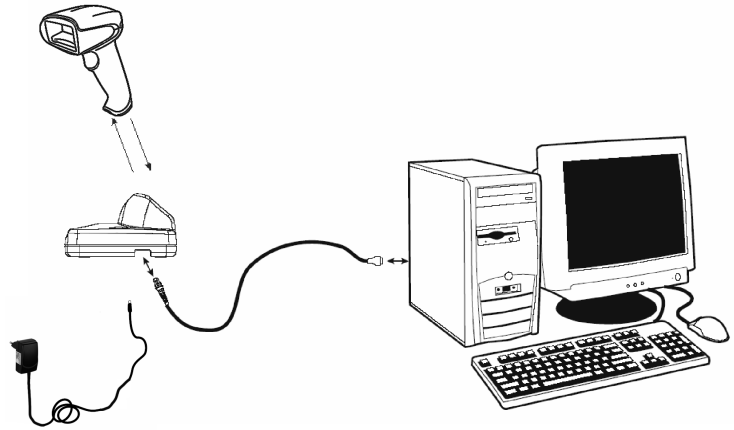

Procedure:

1. Install the USB serial driver (current version at www.leuze.com).
2. Connect the cable for the base station to a free USB port.
3. The scanner acknowledges this connection with a beep.
4. Scan the adjacent 2D code.
5. Open a terminal program or your program for the serial interface, select the new COM port, and make the following settings: baud rate 38,400, 8 data bits, 1 stop bit, no parity, terminator <CR>.

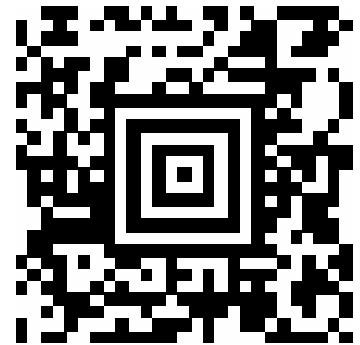

Notice!

To charge the IT 1902, the power supply unit must be plugged in and the hand-held scanner placed in the base station.